

**TEMA** MWB400

External Rotor  
Permanent Magnet Motors



*Practicing the advantage of a new  
permanent magnet motor technology*

*10 - 150 HP*



**TEMA** d.o.o.

phone. +385/52 216 740

fax. +385/52 507 599

email. [info@tema.hr](mailto:info@tema.hr)

[www.tema.hr](http://www.tema.hr)

MWB400

Your ***Permanent*** Power

*MWB400 are unique and advanced permanent magnet motors and generators with external rotor and internal stator.*

# MWB400 PERMANENT MAGNET MOTOR & GENERATOR FAMILY - TECHNICAL DATA

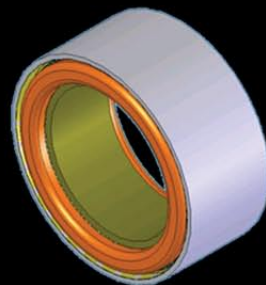

Ext diameter = 400mm  
 Nnom = 325 RPM  
 Nmax = 600 RPM  
 cos φ = 0,92

Isolat.Class = H  
 Thrm.Class = F  
 fnom = 65 Hz  
 fmax = 120 Hz

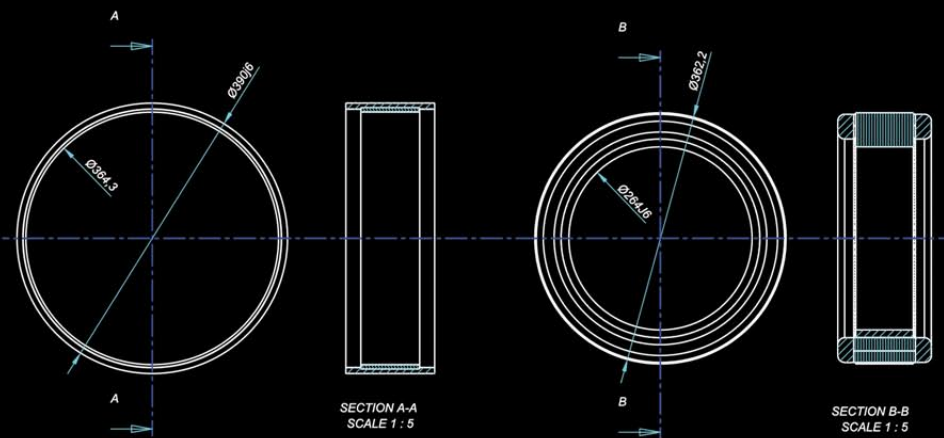
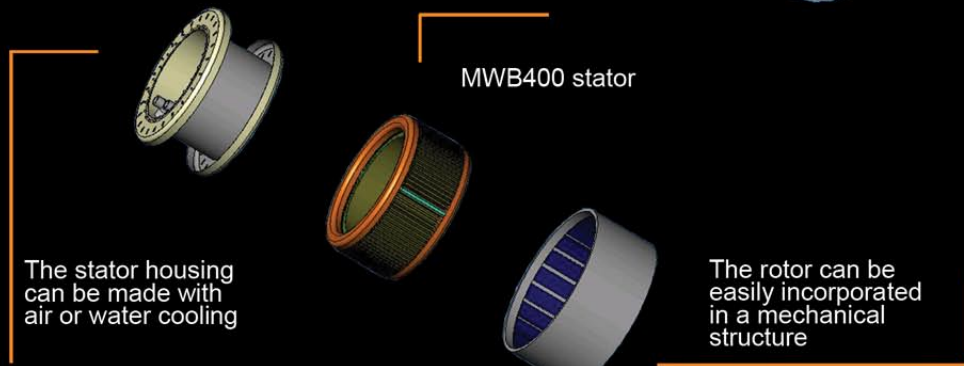

EXTERNAL ROTOR

INTERNAL STATOR

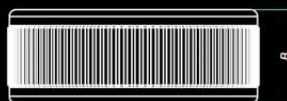
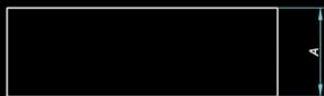

Motor Type	325 RPM			600 RPM			A [mm]	B [mm]	Rot W [kg]	Stat W [kg]	Mot W [Kg]
	Pnom [KW]	Pnom T [HP]	Pnom T [Nm]	Pnom [KW]	Pnom T [HP]	Pnom T [Nm]					
MWB400-01	7,5	10	225	11,2	15	178	86	93	8,5	19,5	28
MWB400-02	15	20	443	22,5	30	358	128	135	12,3	32,0	45
MWB400-03	22,5	30	660	33,7	45	536	170	177	17,2	43,8	61

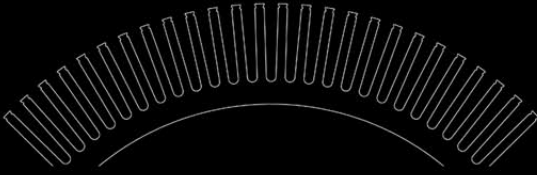

MWB400 is a surface permanent magnet, low speed, synchronous motor and generator family with external rotor and internal stator. Unique and advanced design of these machines offers multiple and innovative applications, high power concentration (W/cm<sup>3</sup>) and large constant power / constant voltage control range.

### FEATURES ■

- Unique design
- Mechanical and chemical PM protection
- Constant torque & constant power control features
- Very low torque ripple
- Low vibration
- High efficiency
- High W/Kg ratio
- Ambient friendly machine
- Low thermal dissipation
- Long life operation

### BENEFITS ■

- Multiple applications
- Lower weight
- Lower cost
- Smoother running
- Constant torque across RPM's
- Constant power control
- Higher efficiency under various conditions
- Chemically protected PM segments

### APPLICATIONS ■

- Industrial applications
- Marine applications
- Wind turbines
- Hydro Turbines
- Electric vehicles traction
- Mining and drilling
- Oil industry
- Power generation
- Paper industry
- Elevators
- Winders
- Winches

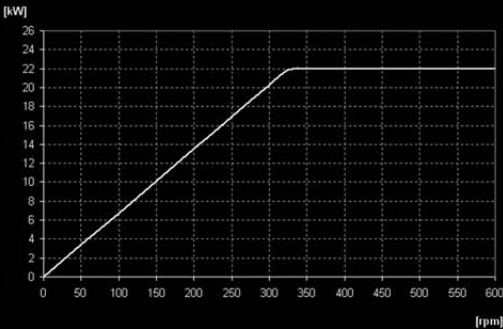

Long constant power range

**TEMA**  
MWB400



Testing the MWB400 for wheel integrated applications



A water or air cooled heat sink can be fitted in the stator



Precise and high quality winding



The rotor is step skewed to reduce torque ripple